

SAM STEVENS INC.

2101 Lubbock Hwy.
Lamesa, Texas 79331

MANUFACTURER OF QUALITY FARM EQUIPMENT

Phone: 806-872-8365 Fax: 806-872-8368

PREMIUM TOOL BAR

3/8" FRONT BAR - 1/4" BACK BAR

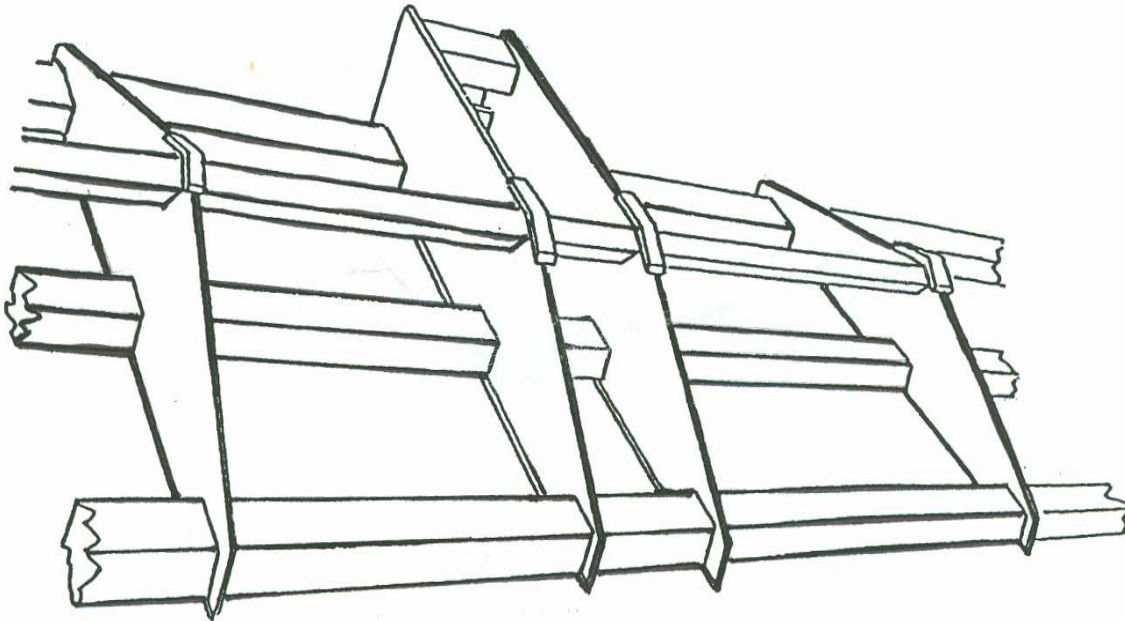

SAM STEVENS INC.

2101 Lubbock Hwy.
Lamesa, Texas 79331

MANUFACTURER OF QUALITY FARM EQUIPMENT

Phone: 806-872-8365

Fax: 806-872-8368

TOOL BAR TUBING

PART NO.	DESCRIPTION	WEIGHT
PTB - 0040	4" x 4" x 1/4"	12.21 lbs.
PTB - 0041	4" x 4" x 3/8"	17.27 lbs.
PTB - 0042	4" x 7" x 3/8"	24.93 lbs.
PTB - 0043	4" x 7" x 1/2"	31.81 lbs.
PTB - 0044	5" x 7" x 3/8"	27.48 lbs.
PTB - 0045	5" x 7" x 1/2"	35.24 lbs.
PTB - 0046	7" x 7" x 1/4"	22.42 lbs.
PTB - 0047	7" x 7" x 3/8"	32.58 lbs.
PTB - 0048	7" x 7" x 1/2"	42.05 lbs.
PTB - 0049	6" x 8" x 3/8"	32.58 lbs.
PTB - 0050	4 1/2" x 7 1/2" x 1/2"	35.80 lbs.

TOOL BARS

Double 4 x 4 Tool Bars

PART NO.	DESCRIPTION	WEIGHT
TBD - 0010	Double 4 x 4 Tool Bar Hitch	159 lbs.
TBD - 0011	WITH Plate and Bolts	170 lbs.
TBS - 0012	EXTRA H.D. Hitch	310 lbs.

DBT - 0013	15' Double 4 x 4 Bar	835 lbs.
DBT - 0014	17' Double 4 x 4 Bar	955 lbs.
DBT - 0015	19' Double 4 x 4 Bar	1085 lbs.
DBT - 0016	21' Double 4 x 4 Bar	1217 lbs.
DBT - 0017	29' Double 4 x 4 Bar	1517 lbs.
DBT - 0018	30' Double 4 x 4 Bar	1555 lbs.
DBT - 0019	31' Double 4 x 4 Bar	1648 lbs.
DBT - 0020	32' Double 4 x 4 Bar	1685 lbs.
DBT - 0021	34' 6" Double 4 x 4 Bar	1828 lbs.
DBT - 0022	37' 6" Double 4 x 4 Bar	1900 lbs.
DBT - 0023	42' Double 4 x 4 Bar	2085 lbs.

Triple 4 x 4 Tool Bars

TBT - 0024	15' Triple 4 x 4 Bar	1085 lbs.
TBT - 0025	17' Triple 4 x 4 Bar	1300 lbs.
TBT - 0026	19' Triple 4 x 4 Bar	1505 lbs.
TBT - 0027	21' Triple 4 x 4 Bar	1705 lbs.

Folding Tool Bar Hinge Parts

FTB - 0028	Folding Tool Bar Hinge Mechanism WITH (2" Pins) for a Double Bar with Cylinders & Hoses
FTB - 0028a	Folding Tool Bar Hinge Mechanism WITH (2" Pins) for a Single Bar with Cylinders & Hoses
FTB - 0029	2" Hinge Pin WITH Nut
FTB - 0030	Flats, Bushing, Pin for Single Bar
FTB - 0031	Flats, Bushing, Pin for Double Bar
FTB - 0032	7 1/2" Bushing
FTB - 0033	4" Bushing
FTB - 0034	1 1/2" Bushing
FTB - 0035	1/2" Bushing

FTB - 0036	Flat Fold for Single Bar
FTB - 0037	Flat Fold for Double Bar

FTB - 0039	30" Row Hinge and Tool Bars
FTB - 0040	40" Row Hinge and Tool Bars

SAM STEVENS INC.2101 Lubbock Hwy.
Lamesa, Texas 79331

MANUFACTURER OF QUALITY FARM EQUIPMENT

Phone: 806-872-8365

Fax: 806-872-8368

PREMIUM TOOL BARS

3/8" FRONT BAR - 1/4" BACK BAR

DOUBLE BAR

PART NO.	DESCRIPTION	WEIGHT
PTB - D029	27' 6" (20' 6" Length of Top Bar)	1405 lbs.
PTB - D030	31' (24' Length of Top Bar)	1575 lbs.
PTB - D031	34' 6" (27' 6" Length of Top Bar)	1680 lbs.
PTB - D032	41' (34' Length of Top Bar)	2285 lbs.

TRIPLE BAR

PART NO.	DESCRIPTION	WEIGHT
PTB - T033	21' (12' 6" Length of Top Bar)	1420 lbs.
PTB - T034	27' 6" (20' 6" Length of Top Bar)	2095 lbs.
PTB - T035	30' (24' Length of Top Bar)	2185 lbs.
PTB - T036	31' (24' Length of Top Bar)	2122 lbs.
PTB - T037	32' (25' Length of Top Bar)	2270 lbs.
PTB - T038	34' 6" (27' 6" Length of Top Bar)	2475 lbs.
PTB - T039	41' (34' Length of Top Bar)	3970 lbs.

SINGLE FOLD

PART NO.	DESCRIPTION	WEIGHT
SFB - 1647	16 Row Flat Fold Premium Bar with Hinge,	
	4 x 7 x 3/8 Tubing, 4 x 7 x 3/8 Tubing	
	with Weld on Hitch	
SFB - 1644	16 Row Flat Fold Premium Bar with Hinge,	
	4 x 4 x 3/8 Tubing, 4 x 4 x 3/8 Tubing	
	with Weld on Hitch	
SFB - 1647a	16 Row Flat Fold Premium Bar	
	4 x 7 - 4 x 7 Tubing, 17" in between the Bars	
	with Weld on Hitch	
SFB - 1644a	16 Row Flat Fold Premium Bar	
	4 x 4 - 4 x 4 Tubing, 17" in between the Bars	
	with Weld on Hitch	

SAM STEVENS INC.

2101 Lubbock Hwy.
Lamesa, Texas 79331

MANUFACTURER OF QUALITY FARM EQUIPMENT

Phone: 806-872-8365 Fax: 806-872-8368

DRAW BARS

PART NO.	DESCRIPTION	WEIGHT
CDB - 1001	Draw Bar, Category 2	60 lbs.
CDB - 1002	Draw Bar, Category 2 WITH Ill Pins	64 lbs.
CDB - 1004	Draw Bar, Category 3	70 lbs.
CDB - 1008	Module Draw Bar, Cat 2, Wide WITH Cat 2 Pins	
CDB - 1009	Module Draw Bar, Cat 2, Wide WITH Cat 3 Pins	
CDB - 1010	Module Draw Bar, Cat 3, Wide WITH Cat 3 Pins	



CAT 2 DRAW BAR

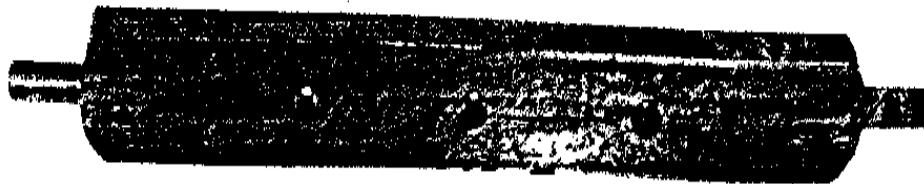

CAT 3 DRAW BAR

SAM STEVENS INC.

2101 Lubbock Hwy.
Lamesa, Texas 79331

MANUFACTURER OF QUALITY FARM EQUIPMENT

Phone: 806-872-8365

Fax: 806-872-8368

E. Z. Y. HITCH

PART NO.	DESCRIPTION
EZY - 1001	EZY Hitch WITH Brace

E. Z. Y. HITCH PARTS

PART NO.	DESCRIPTION
EZY - 102	T - Handle
EZY - 103	EZY Spring

PART NO.	DESCRIPTION
DTC - 1004	Ditch Stop

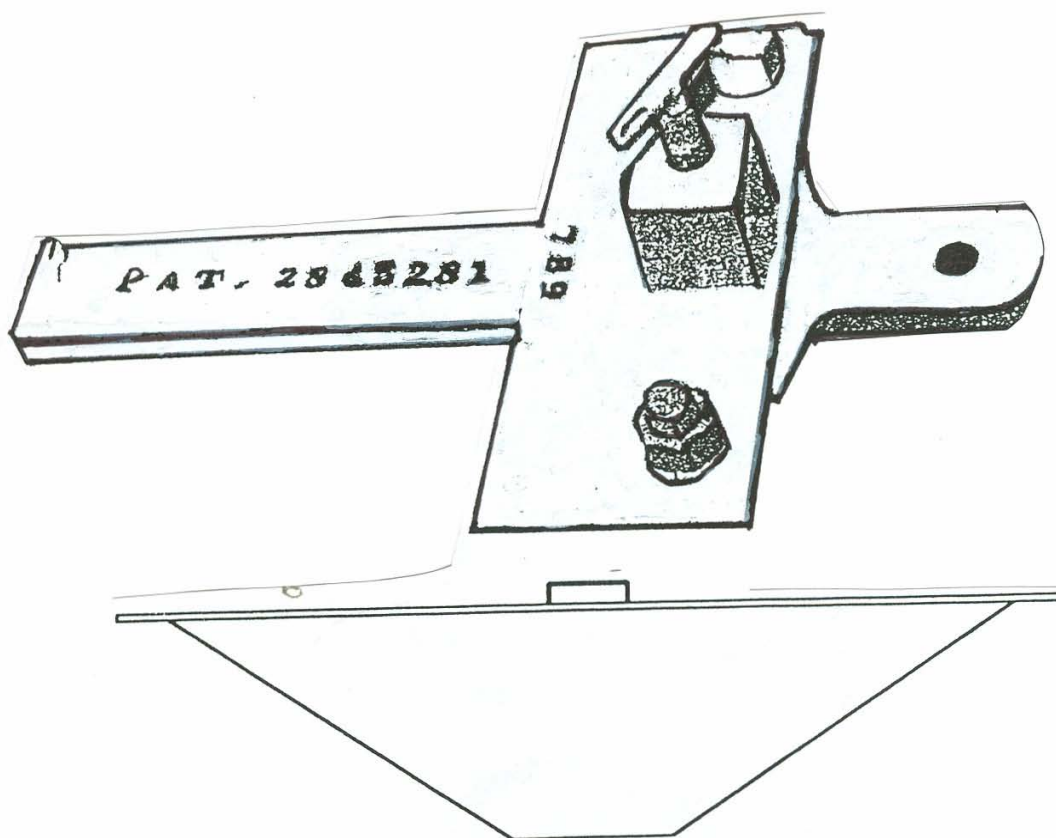

BUMBLE BEE HITCHES

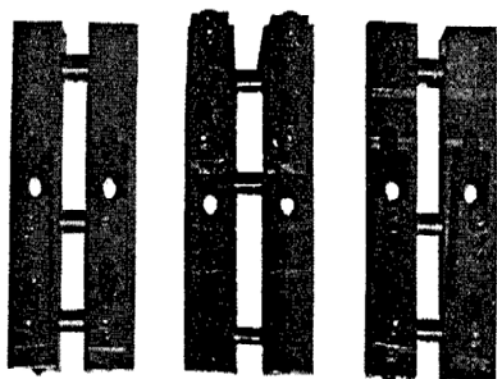

**Bumble Bee 3-point
Hitch for 4½ x 7½**

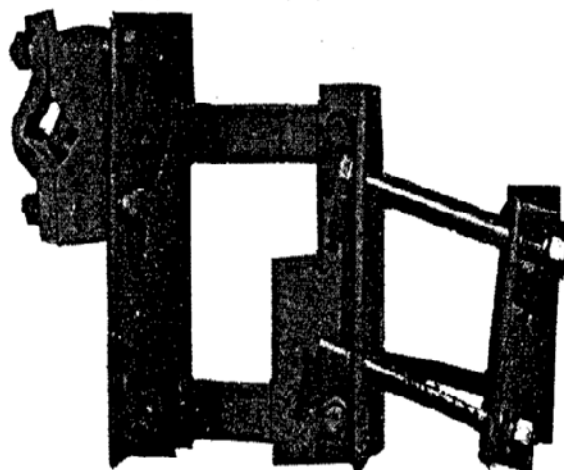

**Bumble Bee Hitch 4½ x 7½ inch bar
to 2¼ inch bar.**

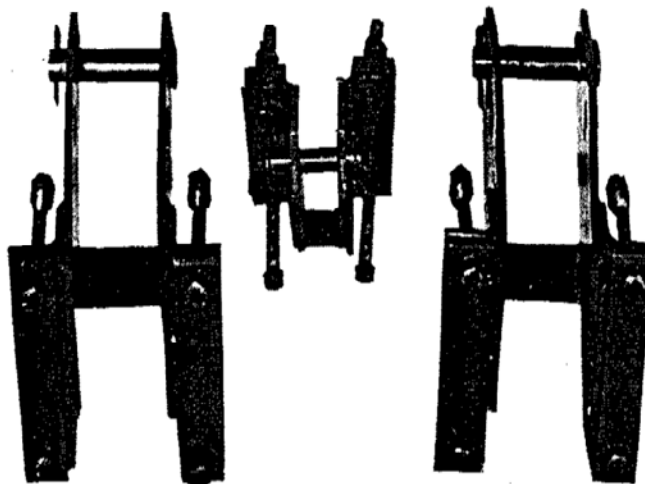

**Bumble Bee 3-point hitch for 4½ x 7½ inch bar.
Category 2 or 3 Quick Coupler.**

SAM STEVENS INC.2101 Lubbock Hwy.
Lamesa, Texas 79331

MANUFACTURER OF QUALITY FARM EQUIPMENT

Phone: 806-872-8365

Fax: 806-872-8368

BUMBLE BEE HITCHES

PART NO.	DESCRIPTION	WEIGHT
BBH - 6025	Bumble Bee Hitch (B.B. Hitch)	60 lbs.
BBH - 6026	3 Point Category 2 Hitch for Bumble Bee Unit	153 lbs.
BBH - 6027	3 Point Category 3 Hitch for Bumble Bee Unit	155 lbs.
BBH - 6028	3 Point Quick Coupler Hitch for Bumble Bee Unit	190 lbs.

REPAIR PARTS
FOR
BUMBLE BEE HITCH

PART NO.	DESCRIPTION	WEIGHT
BBH - 029	Bumble Bee Spacer or Lockdown Unit	30 lbs.
BBH - 030	Bumble Bee Link Arms	4 1/2 lbs.
BBH - 031	Bumble Bee inside Bushing	1/2 lb.
BBH - 032	Bumble Bee Lift Arm Spacer (FLAT)	20 lbs.
BBH - 033	Bumble Bee Lift Arm Spacer (ROUND)	10 lbs.

HITCH PINS

HITCH PINS

STRAIT CAT II OR III
Hitch pins

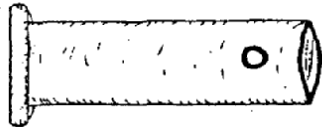

1 7/16"
CAT III pin

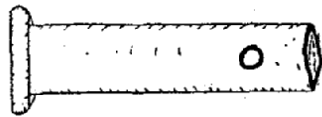

1 1/4" TOP Link pin

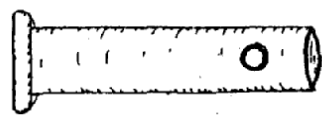

1 1/8" CAT II pin

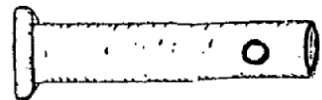

1" TOP Link pin

CAT II & III Hitch pins

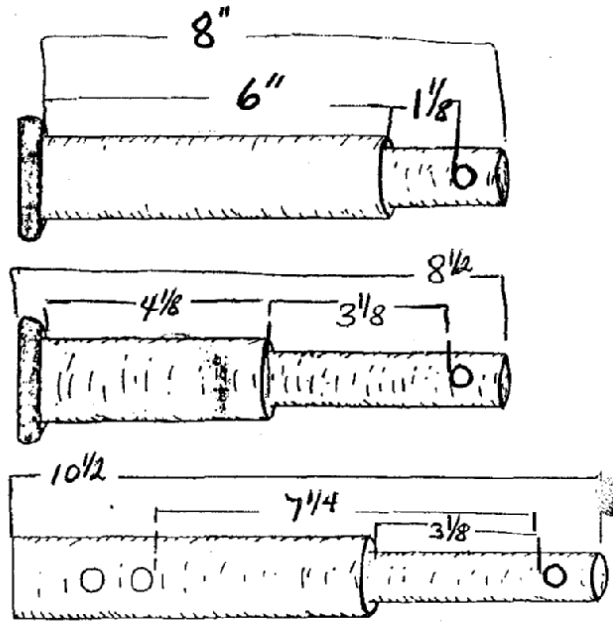

SAM STEVENS INC.2101 Lubbock Hwy.
Lamesa, Texas 79331

MANUFACTURER OF QUALITY FARM EQUIPMENT

Phone: 806-872-8365

Fax: 806-872-8368

HITCH PINS

PART NO.	DESCRIPTION	USEABLE	WEIGHT
HTP - 0107	1" x 6" Top Pin	4.35"	1 1/2 lbs.
HTP - 0108	1" x 7" Top Pin	5.35"	1 1/2 lbs.
HTP - 0109	1" x 8 1/2" Top Pin	6.85"	2 lbs.
HTP - 0106	1" x 10" Top Pin		2 1/4 lbs.
HTP - 0110	1 1/4" x 7" Top Pin	5.34"	2 1/2 lbs.
HTP - 0111	1 1/4" x 8" Top Pin	6.85"	3 lbs.
HTP - 0112	1 1/4" x 9" Top Pin	7.35"	3 3/4 lbs.
HTP - 0113	1 1/8" x 6" Hitch Pin	4.35"	2 lbs.
HTP - 0114	1 1/8" x 7 1/2" Hitch Pin	5.85"	3 lbs.
HTP - 0138	1 1/8" x 10" Hitch Pin		
HTP - 0115	1 7/16" x 6" Hitch Pin	4.35"	3 lbs.
HTP - 0116	1 7/16" x 7" Hitch Pin	5.35"	3 1/2 lbs.
HTP - 0117	1 7/16" x 7 1/2" Hitch Pin	5.85"	4 lbs.
HTP - 0118	1 7/16" x 9" S.S. Hitch Pin	7.35"	4.3 lbs.
HTP - 0119	1 7/16" x 8 1/2" Hitch Pin	6.85"	4 lbs.
HTP - 0120	1 7/16" x 10" Hitch Pin	8.35"	5 lbs.
HTP - 0121	1 7/16" x 10 1/2" Hitch Pin	8.85"	5 lbs.
HTP - 0122	1 7/16" x 11" Hitch Pin	9.37"	5 lbs.
HTP - 0123	1 7/16" x 11" J.D. Hitch Pin	7.25 or 8"	5 lbs.
HTP - 0124	1 7/16" x 12" Hitch Pin	10.37"	6 lbs.
HTP - 0125	1 7/16" x 13" Hitch Pin	11.35"	6 lbs.
HTP - 0126	1 1/4" Hitch Pin WITH Flat for Stalkcutter or Sandfighter		
HTP - 0127	1 7/16" Hitch Pin WITH Flat for Stalkcutter or Sandfighter		
HTP - 0128	SS 1-7/16" x 1-1/8" Hitch Pin, Turndown 4" WITH Ring		4 lbs.
HTP - 0129	SS 1 7/16" x 1 1/8" Hitch Pin, Turndown 2" WITH Ring		4 lbs.
HTP - 0130	1 7/16" x 1 1/8" Planter Hitch Pin Turndown 4"		5 lbs.
HTP - 0131	1 7/16" x 1 1/8" Planter Hitch Pin Turndown 2"		5 lbs.
HTP - 0132	1 7/16" x 9" S.S. Hitch Pin WITH 2" Turndown		4.3 lbs.
HTP - 0133	1 7/16" x 11" JD Hitch Pin WITH 2" Turndown		5 lbs.
HTP - 0138	3/4" Block for 1 1/4" Pin		

SAM STEVENS INC.

2101 Lubbock Hwy.
Lamesa, Texas 79331

MANUFACTURER OF QUALITY FARM EQUIPMENT

Phone: 806-872-8365 Fax: 806-872-8368

THREE POINT HITCH

PART NO.	DESCRIPTION	WEIGHT
TPH - 0100	J.D. Planter 3 Point Hitch	215 lbs.
TPH - 0103	Regular 4 X 4 Hitch	159 lbs.
TPH - 0104	Heavy Duty 4 x4 Hitch	170 lbs.
TPH - 0105	Extra Heavy Duty 4 x 4 Hitch	308 lbs.

J.D. PLANTER HITCH

